



art metal

01 VERA LED

F.P.H. Art Metal Sp.j.

Ul. Jabłoniowa 124, 83-331 Łapino Kartuskie, Poland
Tel. 0048 58 681 80 78, Fax: 0048 58 681 80 64
www.art-metal.pl e-mail: biuro@art-metal.pl

Construcion:

The unit consists of a metal basket (1) holding a shade (2). A disk (4) separating electrical compartment from lighting compartment is attached to a luminary cover (3) on the top. A LED light source radiator (6) is mounted to the disk (4). LED module is mounted to the radiator (6) a tightly closed with a lens (5). Module is powered with a voltage power supply (7). The luminary cover (4) is mounted to the luminary body (1) with a hinge and closed with a screw so no additional tools are necessary. The luminary is sealed with a gasket (8).

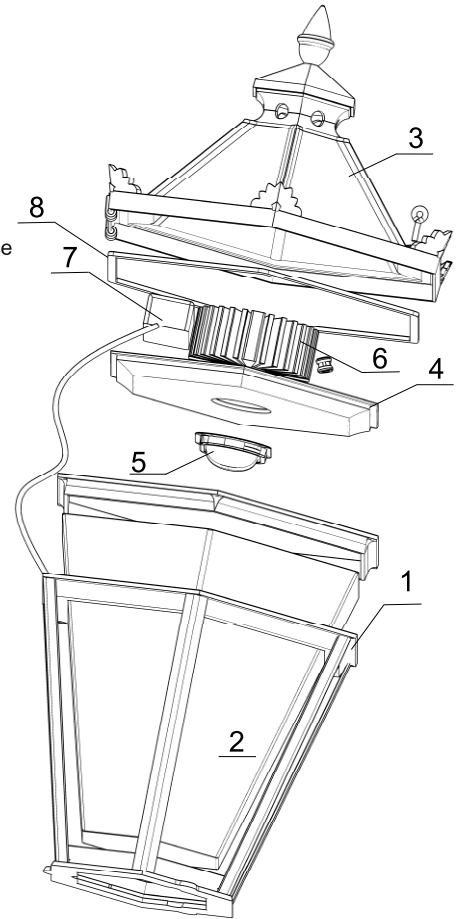

Mounting instruction:

- *)- Put the shade (2) into the basket (1)
- *)- Screw the radiator (6) to mount an LED light source to the disk (4)
- *)- Connect the electrical cables to the terminals of power supply (7)
- Screw tightly disk (4) to the luminary cover (3)
- Close the cover using hand.
- Luminary is mounted to the lantern depending on the pole construction - either hanging on M20 thread or mounted on the top of the pole on $\varnothing 45\text{-}\varnothing 90$ diameter.

If any lantern elements are supplied factory-mounted, the mounting stages marked with *) should be omitted (as this has already been done by the manufacturer).

TECHNICAL DATA:

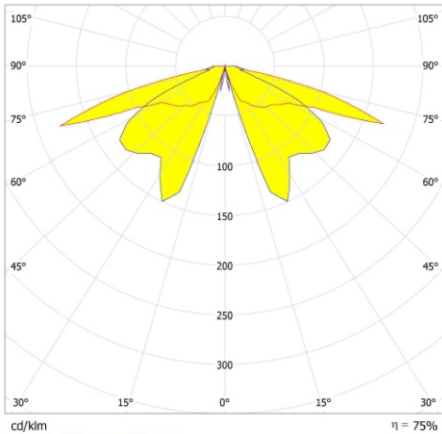

Photometry (polar plot)

Power: ~230/50Hz

Protective class: I

IP65 -electrical part

IP65 -optical part

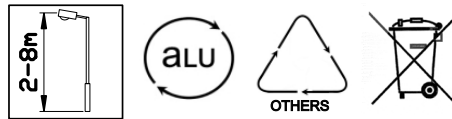

ELECTRICAL DIAGRAMS:

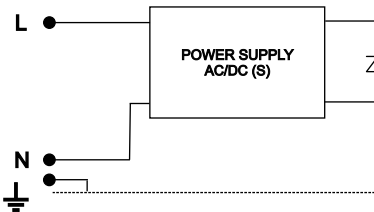

1. Module LED -basic power supply (S)

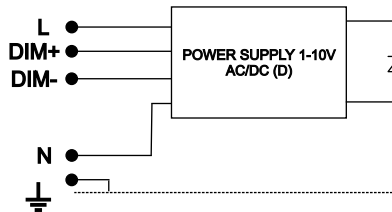

2. Module LED -dimnable power supply (D)

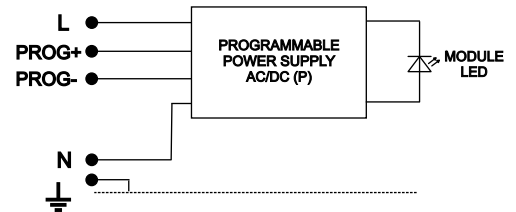

3. Module LED -programmable power supply (P)

Type	Light-prod. element	Luminous flux[lm]		Weight [kg]	Pn [W]	Luminary dimensions	
		3000K (830)	4000K (840)				
01L-22W	CXB2540	2990	3170	14,5	22		
01L-33W	CMA2550	4286	4609	14,5	33		
01L-38W	CMA2550	4842	5207	14,5	38		
01L-50W	CMA2550	6131	6593	14,5	50		
01L-58W	CMA2550	6896	7415	14,5	58		

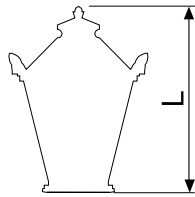

Wind area
A = 0,21m²

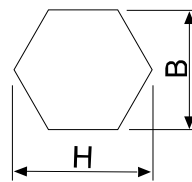

L/H/B
740/530/460



WARNING !! The weight of the unit may slightly differ for individual production batches.

